

**CAUTION**  
Read instructions carefully and turn electricity off at main fuse box before beginning installation

1. Turn the power off.
2. Take threaded pipe from parts bag and screw in screw collar loop a minimum of 1/4". Lock into place with hexnut.
3. Run another hexnut down threaded pipe almost touching first hexnut. Now screw threaded pipe into mounting strap. mounting strap must be positioned with extruded thread faced into outlet box. Threaded pipe must protrude out the back of mounting strap. Connect mounting strap to outlet box.
4. Unscrew the threaded ring from screw collar loop. Take canopy and pass over screw collar loop. Approximately one half of the screw collar loop exterior threads should be exposed. Adjust screw collar loop by turning assembly up or down in mounting strap. Remove canopy.
5. After desired position is found, tighten top hexnut up against the bottom of the mounting strap.
6. Slip canopy over screw collar loop and thread on threaded ring. attach chain (with fixture connected) to bottom of screw collar loop. Unscrew threaded ring, let canopy and threaded ring slip down.
7. Weave electrical wire and ground wire through chain links no more than 3 inches apart, Pass wire through threaded ring, canopy, screw collar loop, threaded pipe and into outlet box.
8. Grounding instructions: (See illustration A or B).  
A) On fixtures where mounting strap is provided with a hole and two raised dimples. Wrap ground wire from outlet box around green ground screw and thread into hole.  
B) On fixtures where a cupped washer is provided. Attach ground wire from outlet box under cupped washer and green ground screw, and thread into mounting strap.

If fixtures is provided with ground wire. connect fixture ground wire to outlet box ground wire with wire connector. (Not provided.) After following the above steps.

Never connect ground wire to black or white power supply wires.

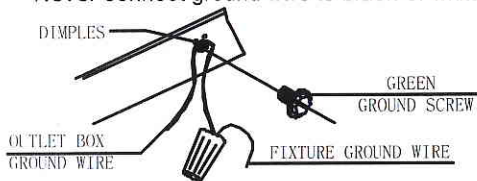

illustration A

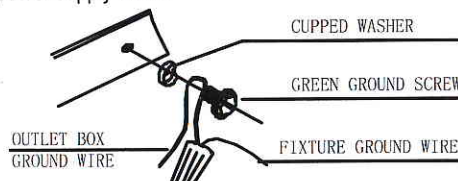
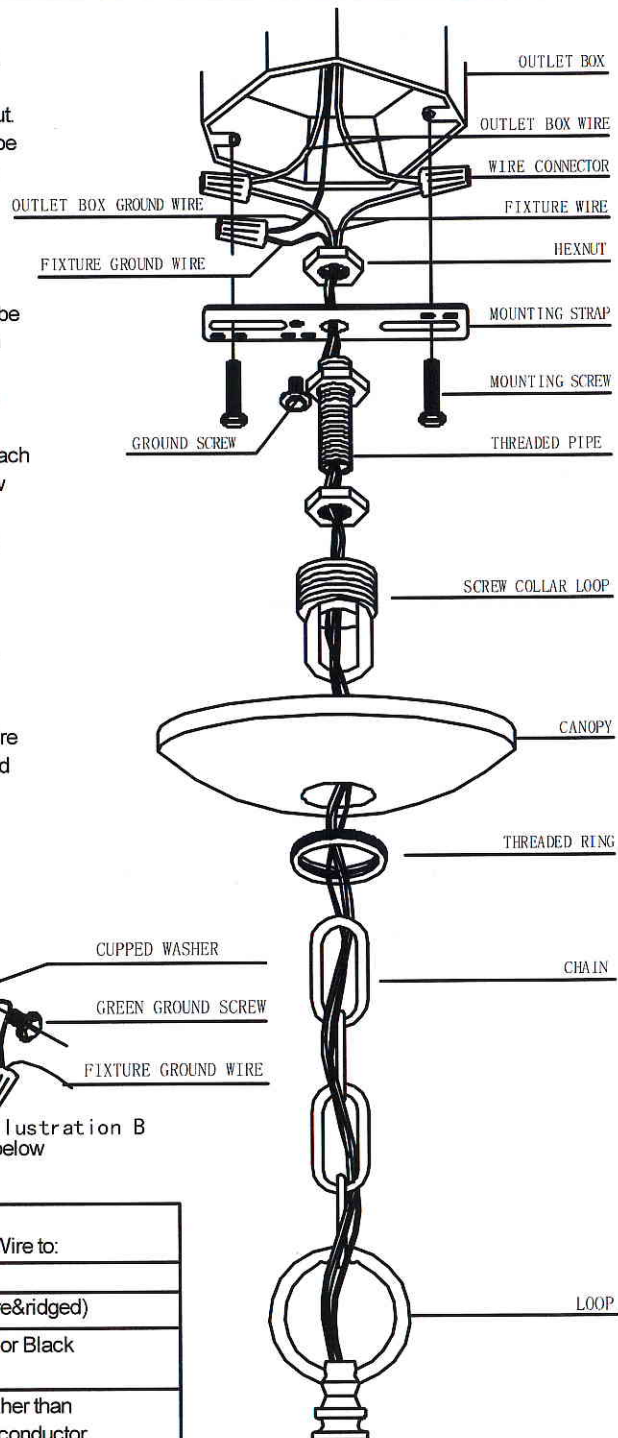
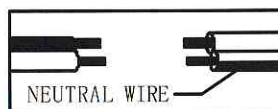

illustration B

9. Make wire connections (connectors not provided) Reference chart below for correct connections and wire accordingly.

Connect Black or Red House Wire to:	Connect White House Wire to:
Black	White
*Parallel cord (round & smooth)	*Parallel cord (Square & ridged)
Clear, Brown, Gold or Black without tracer	Clear, Brown, Gold or Black with tracer
Insulated wire (other than green) with copper conductor	Insulated wire (other than green) with silver conductor

\*Note: When parallel wire (SPT-I & SPT-II) is used, The neutral wire is square shaped or ridged and the other wire will be round in shape or smooth. (See illus.)



10. Raise canopy to ceiling.
11. Secure canopy in place by tightening threaded ring onto screw collar loop.

139X-ND3

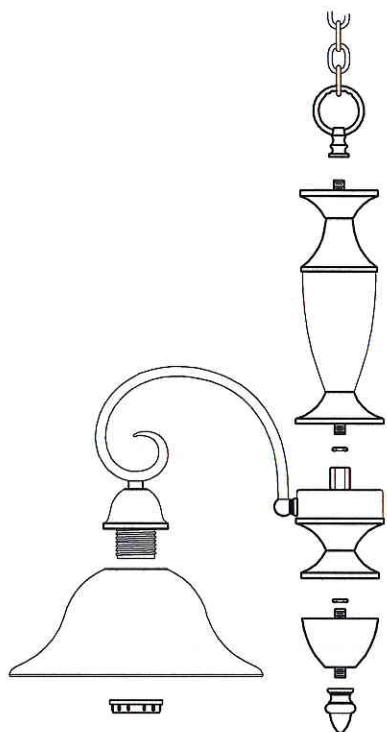

139X-GM4

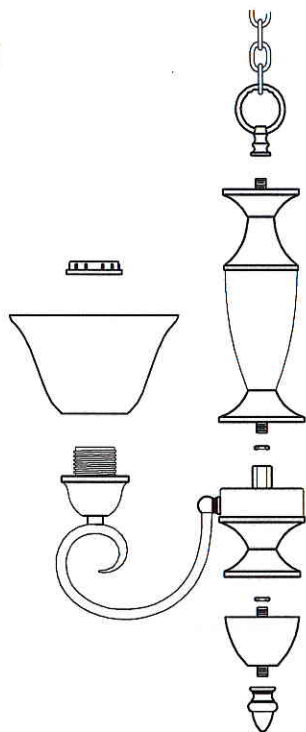

8505-ND3  
8606-ND3  
5919-ND3

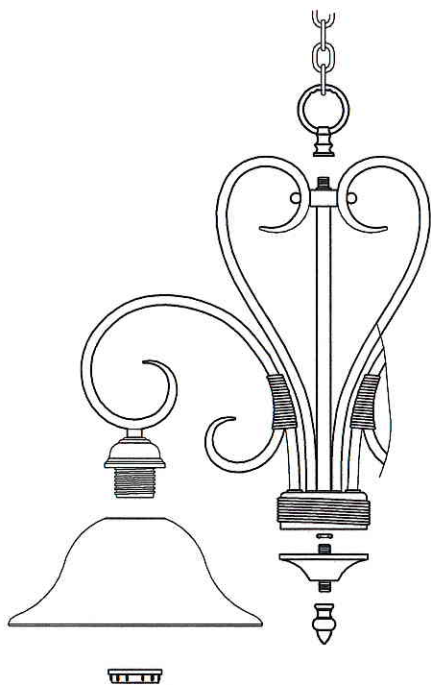

8505-GM4  
8606-GM4  
5919-GM4

